

BEFORE INSTALLING THE SHADE YOU MUST REMOVE THE SHADE FROM THE PACKAGING.

Cut the tie wraps with scissors, do NOT use a knife. Open the top of the cardboard clamps and remove the shade.

Remove the bracket from the headrail. Using a cloth-covered, flat blade screwdriver, push up on the front tab of the mounting bracket to release the front of the headrail. Rotate the headrail downward and out from the bracket.

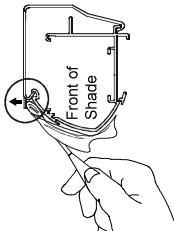

BASICS

- A few simple tools are required:
- Measuring tape
 - Power drill, drill bits
 - Hex head and/or Phillips driver bit
 - Pencil

Additional fasteners other than those sent with your shade may be required depending on the mounting surface. Wallboard and plaster require the use of anchors such as expansion or toggle bolts. Brick, tile or stone need special plugs and drill bits. Remember to always pre-drill holes in wood to avoid splitting.



Mounting Bracket Hex Head Screw Extension Bracket Spacer Block Hold Down Bracket

BRACKET INSTALLATION

Shade Width	# of Brackets
<= 38"	2
38" >= 72"	3
72" >= 106"	4
> 106"	6

BRACKET PLACEMENT

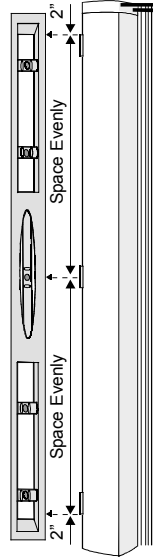

Note: Measure and mark all bracket locations before installing. Placement is the same for inside and outside mounts. 2" in from the ends of the headrail and mark the bracket on the mounting surface. Additional brackets evenly between the end brackets. Be bracket placement to accommodate obstructions to the headrail, such as window cranks or handles.

NOTE: Brackets are mounted with the flat part up.

INSIDE MOUNT APPLICATIONS

- Align the tops of each installation bracket to the top of the window opening and attach using two screws per bracket.
- The minimum mounting depth for an inside mount is 1".
- A minimum of 2 5/8" is needed to fully recess the shade.
- Align the brackets to the inside of the mark on the mounting surface.
- Adjust the bracket placement to accommodate obstructions to the bottom rail, such as a window crank or handle.
- Use a carpenter's level to check that the brackets are level and aligned. Attach using two screws.

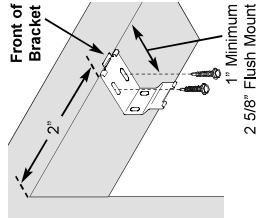

OUTSIDE MOUNT APPLICATIONS

- Attach the back of each installation bracket using two screws per bracket.
- Align the brackets to the inside of the mark on the mounting surface.
- The minimum mounting height for outside-mounted shades is 1".
- Use a carpenter's level to check that the brackets are level and aligned.

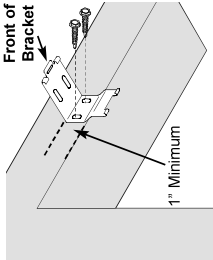

SPACER BLOCKS (OPTIONAL)

- Each spacer block projects brackets 1/2" away from the mounting surface.
- Mount spacer blocks with the solid side facing the mounting surface.
- Use two mounting screws. Screws should be long enough to secure the bracket to the mounting surface.
- Use a maximum of three spacer blocks per bracket.

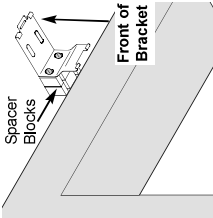

EXTENSION BRACKETS (OPTIONAL)

- Extension brackets project installation brackets up to 3" away from the mounting surface. This provides additional clearance for obstructions such as window cranks or handles.
- Use a carpenter's level to check that the extension brackets are level and aligned. Attach using two screws.
- Attach the installation brackets to the underside of the extension brackets using the provided screws and nuts.

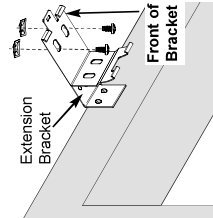

SIDE MOUNT APPLICATIONS

Side mount the headrail when conventional mounting techniques will not work, for example, in an arched window opening. The maximum width of a side mounted shade is 48".

- Mount the extension brackets on a surface at least 1 1/2" wide, as shown.
- Attach the installation brackets to the underside of the extension brackets using the provided screws and nuts.

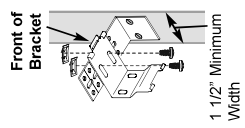

INSTALL THE SHADE

- Note:** Do not remove the low tack protective tape from the face of the headrail until after the headrail is installed.
- With the colored side of the shade facing you, insert the headrail at an angle so the back tab on the bracket fits into the back groove on the headrail.
 - Rotate upward to snap into place.

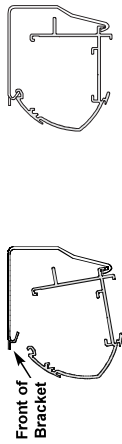

OPERATE THE SHADE

- Raising the Shade**
 - To raise the shade, pull on the front of the cord loop.

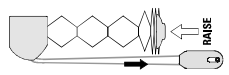

Expanding the Vanes

- Pulling on the front of the cord loop at any time will also expand the vanes, blocking view through the shade.



Lowering the Shade

- To lower the shades, pull on the rear of the cord loop.

Compressing the Vanes

- Pulling on the rear of the cord loop at any time will also compress the vanes, permitting view through the shade.

Tip: If at any time the vanes do not open and close uniformly, "toggle" the cord loop by alternately pulling on the front and back cords in rapid succession.

Installation Instructions

Odysee™ Insulating Blinds with Continuous Cordloop Hardware

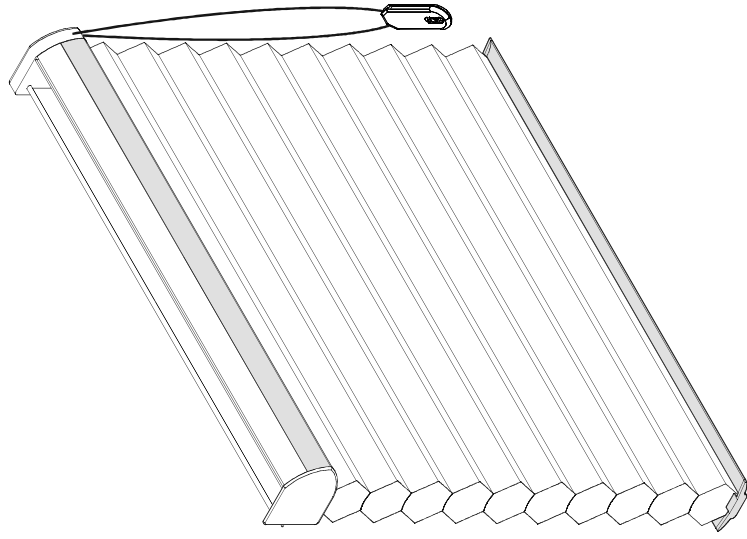

Our window fashions represent a design breakthrough in style, efficiency and function. The unique hardware system is designed to provide years of reliable service when properly installed.

Please take a few minutes to read through these instructions before beginning.

CHILD SAFETY

Install Tension Device

The Tension device reduces the hazards of strangulation and entanglement of young children by limiting access to the control cord. Anchor the Tension Device that is attached to the blind's control cord, to the window frame or wall, so that young children cannot pull the cords around their necks.

- Lower the blind.
- Hold the Tension Device upright and position the device using one of the three methods shown.
- Position the Tension Device so that the Tension Device and the control cord do not interfere with raising or lowering the blind. The Tension device should be installed without stretching or pulling down on the control cord. Stretching the cord will cause excessive wear. Do not twist or cross the control cord.

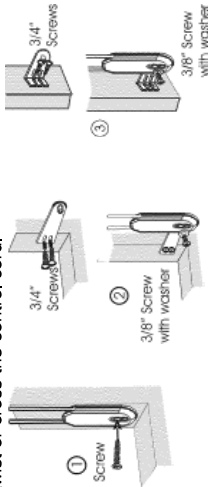

TROUBLESHOOTING

PROBLEM	SOLUTION
<p>One or several vanes are pushed in (concaved).</p> <p>Concaved Cells</p>	<p>Use your hands to manually push the vane out.</p> <p>Push Out Concaved Cells With Your Finger</p>
<p>The lift cords appear loose or wavy.</p>	<p>Operate the cord loop until any slack is taken up, and the cords appear taut. The 'wavy' lines should disappear.</p>
<p>The shade is fully lowered, but the vanes seem to hang unevenly.</p> <p>Collapsed Cell Toggle Cord Alternately</p>	<p>If the vanes do not open and close uniformly, "toggle" the cord loop by alternately pulling on the front and back cords in rapid succession.</p>

HOLD-DOWN BRACKETS (OPTIONAL)

- Lower the shade with the vanes fully expanded and place the pins from the hold-down brackets into the bottom rail end caps.
- Position the pin at the TOP of the slot and then mark the bracket hole location.
- Check that the brackets are level and aligned. Attach using two screws.

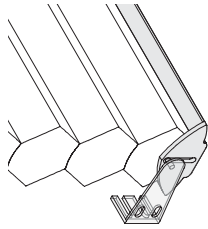

REMOVE THE SHADE

- Using a cloth-covered, flat blade screwdriver, push up on the front tab of the mounting bracket to release the front of the headrail.
- Rotate the headrail downward and out from the bracket.

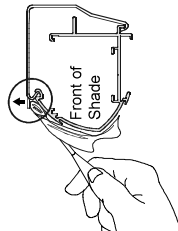

CARE AND CLEANING

Convertible shades are made of an anti-static, dust-resistant fabric which repels dirt and dust. The following options are available if your shade needs cleaning.

Dusting

Regular light dusting with a feather duster is all the cleaning that is needed in most circumstances.

Vacuuming

Use a hand-held vacuum with low suction for more thorough dust removal.



Spot-Cleaning

- Prepare a solution of warm water and mild dishwashing detergent.
- Dampen a clean cloth in the solution and wring it out.
- Dab the spot with the dampened cloth until the spot is gone. Do not rub the fabric fabric.
- Allow the shade to dry in the completely lowered and expanded position.

Ultrasonic Cleaning

Convertible shades, except those made with light-dimming fabrics, can be ultrasonically cleaned by a professional.

- Specify that a mild detergent solution be used.
- Never immerse the headrail in the solution.
- Allow the shade to dry in the completely lowered and expanded position.

Extraction

le shades can be professionally cleaned using the extraction method (On-Site cleaning). Method of injection/extraction is required for light dimming



created using
BCL easyPDF
Printer Driver

[Click here to purchase a license to remove this image](#)